

Thank you for purchasing a Clayton Off Road Mfg Long arm suspension.

Please check to make sure you have all necessary parts before you start your install.



PD-LJ40	UK-LJ	Clayton Long Arm 4-Link Kit
	JKS-2001	JKS Sway Bar Disco's
	B-BL3	Corm brakelines
	CO-LJ-4.0-F	Corm Front coils
	CO-LJ-4.0-R	Corm Rear coils
	DP-LJ	Drop pitman arm
	TB-DB-LJ	Adjustable trackbar & drop bracket
	AB-TJLJ-LSCK	Shock bracket kit
	RAB05	Rear Spring retainer
	52005917	Front Spring retainer

* Shock can be added to any package deal for an additional charge.

If you are missing any of the above items, or are unclear about what parts you need to call and ask before you begin your installation process.

WARNING: Suspension systems and their components are designed to enhance your vehicles offroad performance. This may cause your vehicle to handle differently then it did from the factory. These systems and any components should be installed by certified technicians. Attempts to install these products without proper knowledge can lead to poor performance, or possible failure, which may jeopardize the safety of the vehicle and its passengers. Take extra care when operating a modified vehicle and thoroughly inspect your vehicle before and after every offroad use.

Clayton Off Road Mfg. – 1261 Meriden Road – Waterbury – CT – 06705 – (203) 757-0339 sales@claytonoffroad.com

Tool requirements

1. 175A or greater mig welder
2. Plasma cutter and or a good 4.5" grinder with cut off wheels.
3. Four large jack stands, ramps or a 4-post drive on lift works best.
4. Various wrenches and shop tools for removing and installing control arms.
5. A 1 7/16 wrench is needed to tighten the upper control arm jam nuts, and a 46mm wrench is needed to tighten the lower control arm jam nuts.

Front Arms Installation Procedures

1. Put the truck up on jack stands or lift.
2. Support the transmission using a floor jack.
3. Remove belly pan.
4. Remove the paint from the frame rail from the front belly pan bolt forward about 6" on the bottom and about 1/2" up each side.
5. Clamp a piece of flat metal to the outside of the frame rail about 1" forward from the front belly pan bolt hole.
6. For 2005+ models (including Rubicon and Unlimited) it should be 3.625" from the center of the front belly pan bolt hole.
7. Tack the bracket in at the four corners.

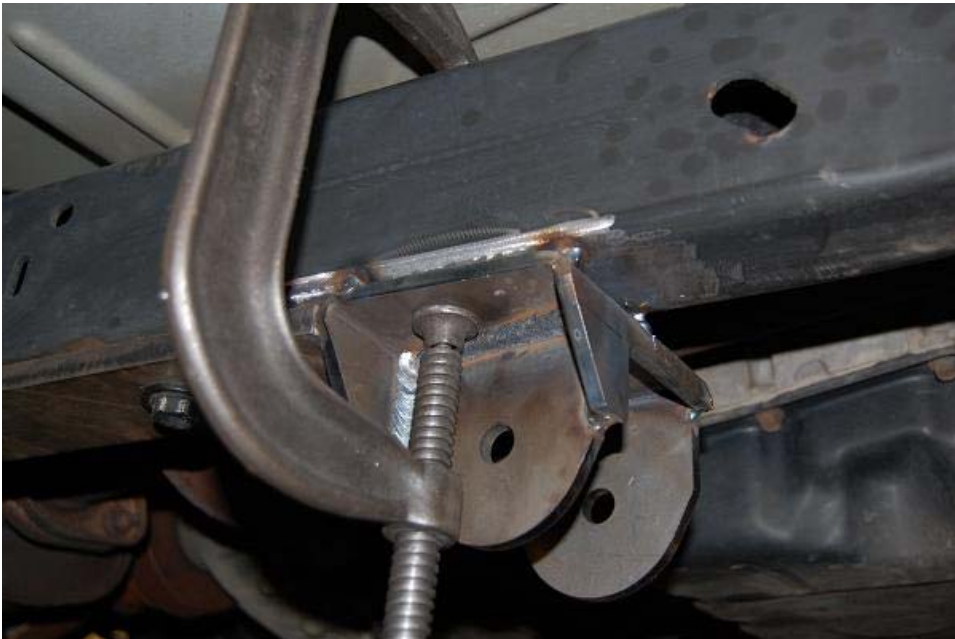

- 8.
9. Remove clamps and weld all four sides. It may be easier to weld the inside with the drive train pushed way up or the exhaust removed.
10. Repeat steps 4 through 8 on the other side.
11. Set both lower control arms to the same length about 36", you should be able to put the bolts in both ends with the arms side by side. This will be about right for a 4.5" to 5.5" lift. Final adjustments can be made later to center the axle if needed.
12. Remove one upper and lower arm on the same side.
13. Remove the lower control arm bracket on the frame. The best way is to use a 4.5"x.045" cut off wheel. Make a cut up the inside corner of the bracket up to the frame then across the back of the bracket along the bottom of the frame rail. Next cut about two thirds of the way through the weld at the top of the bracket on the outside. Using a hammer or large adjustable wrench you can now bend the bracket out and it will pop off the frame. Then cut through the weld in the bracket the same way on the inside and snap it off. Grind the frame rail smooth and paint the new bracket and frame rail where the old bracket was.
14. Install the lower arm at the axle side first. Swing the arm up into the frame side bracket. The Johnny Joint may need to be twisted for proper alignment. You'll have to roll the tire forward to align the bolt hole.

15. Put a bottle jack under the spring perch on the driver's side in front of the axle tube to hold the pinion angle.
16. Repeat steps 11 through 13 on the other side.
17. Once you have the pinion angle set where you want it install the upper front arms. Do not worry about them being the same length; just adjust them so the bolts go in on both sides.
18. Tighten the four lower control arm bolts, the four upper control arm bolts and lock the jam nuts on all four arms. You can slide a large screwdriver in along side the Johnny Joint to keep it aligned while locking the jam nut.
19. Now is the best time to swap out springs, shocks and steering components. If you have purchased our trackbar and drop bracket, part of the package deal, please refer to the trackbar installation below.
20. Grease all Johnny Joints.

Rear Arms Installation Procedures

1. Remove muffler. It will have to be moved or replaced later with a smaller unit to clear control arms.
2. Remove the paint from the frame starting about 27" back from the new front mount 6" towards the rear of the frame rail on the bottom and about ½" up each side
3. Clamp a piece of flat metal to the outside of the frame rail about 27" back from the new front control arm mount. Do this just like you did for the front bracket.
4. Clamp the front control arm bracket in place. It should be 27.447" from the back of the new front control arm mount to the front of the new rear control arm mount. Make sure it's pressed tightly against the flat stock, which should be clamped to the frame rail. Make sure you measure parallel with the frame rail to locate the bracket.
5. Tack the bracket in at the four corners.



- 6.
7. Remove clamps and weld all four sides.
8. Remove the lower control arm bracket on the frame. The best way is to use a 4.5"x.045" cut off wheel. Make a cut up the inside corner of the bracket up to the frame then across the back of the bracket along the bottom of the frame rail. Next cut about two thirds of the way through the weld at the top of the bracket on the out side. Using a hammer or large adjustable wrench you can now bend the bracket out and it will pop off the frame. Then cut through the weld in the bracket the same way on the inside and snap it off. Grind the frame rail smooth and paint the new bracket and frame rail where the old bracket.
9. Repeat steps 2 through 7 on the other side.
10. Remove the rear axle from the vehicle. If the tires are left on it makes it easy to handle and work on. The axle can be left in the vehicle but makes the job more difficult.
11. Remove the upper control arm mounts and grind the axle tubes smooth.

12. In most application you should be able to reuse the factory breather hole and brakeline distribution block. In most cases you will need to remove the brakeline bracket on the passenger side temporarily. Then reinstall it once your welding is complete. Center the truss on the axle. Make your measurements from the rim or brake assembly. Don't use the differential housing as a reference point.
13. Refer to the LJ low pinion rear axle truss position drawing for truss angle setting.
14. Tack weld into place in four places on both legs of the truss.
15. Weld all four sides of both legs of the truss.
16. If you purchased our lower shock conversion kit, or purchased the package deal this is a good time to install the new lower shock mounts. Please refer to the shock installation below.
17. If you purchased our rear spring retainers, or purchased the package deal this is a good time to drill and tap the lower spring cup for the 3/8-16 bolt.
18. Paint truss and axle tubes.
19. Put the axle back under the vehicle.
20. Set both lower control arms to the same length about 31", you should be able to put the bolts in both ends with the arms side by side. This will be about right for a 4.5" to 5.5" lift. Final adjustments can be made later to center the axle if needed.
21. Install the lower arm at the axle side first. Swing the arm up into the frame side bracket. The Johnny Joint may need to be twisted for proper alignment. You'll have to roll the tire forward to align the bolt hole.
22. Repeat step 19 on the other side.
23. Put the springs back in and a bottle jack under the pinion to hold the pinion angle. Now is the best time to swap out springs and shocks if needed.
24. Install upper and lower spring retainers if purchased reusing factory upper bolts, and supplied 3/8 grade 8 bolt with lock washer.
25. Once you have the pinion angle set where you want it you will have to center the axle under the vehicle. I find a come along or ratchet strap works well to pull the body over. Make your measurements from the same reference point on both sides.
26. Install the upper arms on the frame side first.
27. Adjust them to the proper length and put the bolts in on the axle side. Do not worry about them being the same length; just adjust them so the bolts go in on both sides. You may have to twist the Johnny Joint to make it go in. Keep the amount of thread engaged equal from one side to the other. Meaning do not have one adjuster completely closed up, and the other one over extended.
28. Tighten the four lower control arm bolts, the four upper control arm bolts and lock the jam nuts on all four arms. You can slide a large screwdriver in along side the Johnny Joint to keep it aligned while locking the jam nut.
29. Grease all Johnny Joints.

Exhaust Modifications

1. We have found that a smaller shorter muffler welded in right after the factory cat will fit on the LJ models. If you have a 1" to 2" body lift it is possible to have a tail pipe bent to go up and over the rear upper control arm. It will be tight without a body lift and you may have to go under the arm. Another option is to just put a turn down at this point.



- 2.

Drop Track Bar Installation.

1. Remove factory trackbar.
2. Grind paint away from both sides of frame and around factory trackbar bracket where it makes contact with our new trackbar drop bracket.
3. Bolt up, using the supplied washer and nut. This is intended for positioning ONLY, and needs to be fully welded.
4. Located below is a picture to better illustrate how and where your trackbar drop bracket should be welded.



- 5.
6. Let bracket cool, and paint.
7. Install axle side of your new adjustable trackbar reusing your factory bolt.
8. Set vehicle track.
9. Adjust Johnny Joint so that the supplied 9/16s bolt easily slides through the new trackbar drop bracket.
10. Tighten upper and lower trackbar bolts and jam nut making sure the Johnny joints stays centered in trackbar drop bracket.

TJ/LJ Lower shock conversion kit

1. Cut off OEM lower shock brackets. They will NOT be reused.
2. There is a left and right bracket. Please make sure the shock bracket angles in towards the center of the Jeep. Grind the backside of the control arm tabs and axle area and weld. This bracket is designed to add clearance by removing the stock OEM shock bracket, strengthen the lower control arm brackets, and properly space and locate the shock.
3. These brackets reuse the stock lower oem bolts, and the shock bolts back into the stock upper location.
4. Let brackets cool, paint, and install shocks.



TJ/LJ Rear spring retainers

1. Remove upper bumpstop and bumpstop cup. (Upper bolt should be a 15mm.)
2. Drill and tap a 3/8-16 hole in the lower spring bucket cup.
3. Install springs. Make sure the factory upper spring isolator is in place.
4. Reuse OEM upper bolts clamping the spring.
5. Clamp lower spring using the supplied 3/8-16 bolt and lock washer as seen below.



LJ axle bracket kit location drawing

Standard setup 5.5° of lift SYE kit the pinion angle will be approx. 19 degrees.
 If you are using a high pinion axle the pinion angle will be approx. 5 degrees less.
 This means the truss should be welded on at approx. 7 degrees.
 Remember these are approx. angle make sure you double check angles
 for your setup.

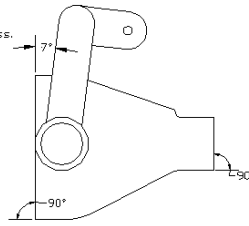

Jack stand setup view high pinion axle

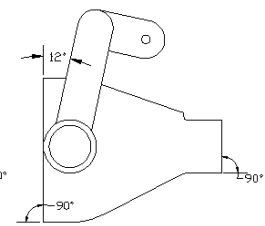

Jack stand setup view low pinion axle

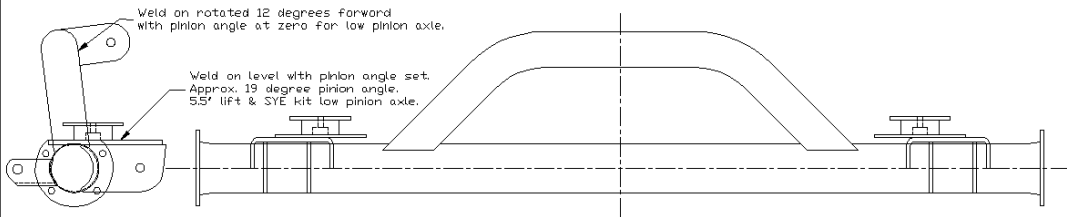
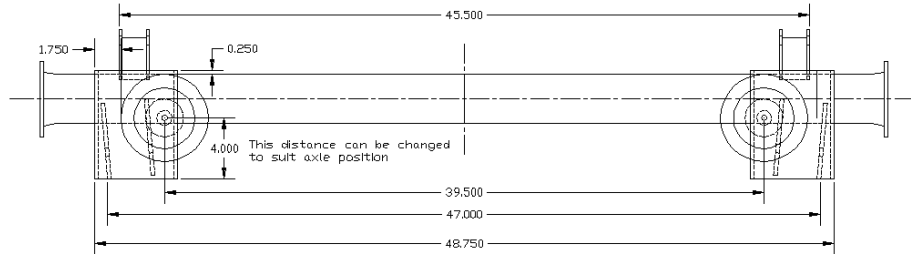

2004 & Up LJ Long Arm Kit
Bracket Location Drawing
Bottom View

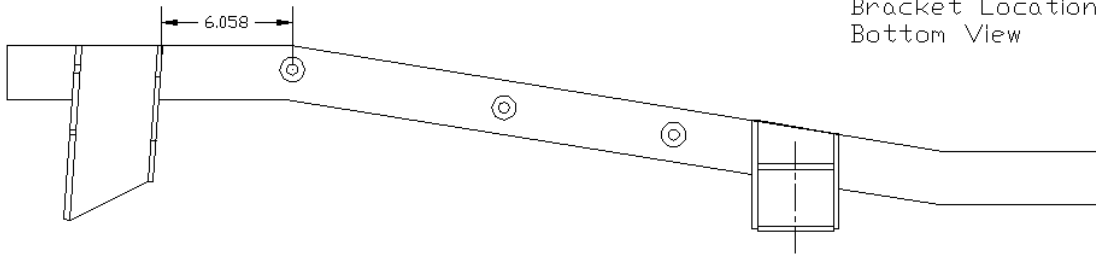

Use the dimensions from this drawing along with the TJ installation instructions available at claytonoffroad.com for bracket installation

Front →

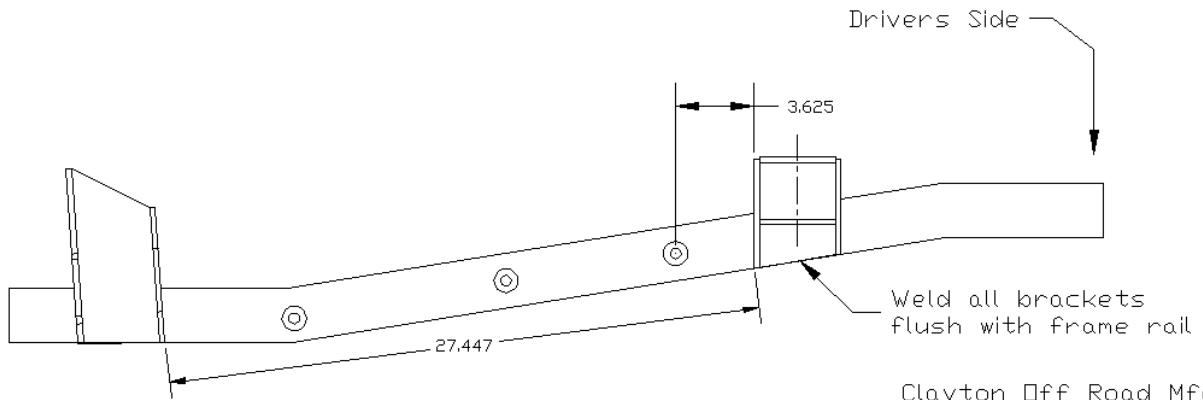

Clayton Off Road Mfg, LLC

Damage or Missing Parts Policy: If you receive a product that is damaged or missing parts you must contact us within 14 days to arrange replacement. You maybe required to submit photos of damaged parts before new parts are sent. Damage parts maybe request to be returned for inspection.

Return Policy: You have 30 days to return a product in it original packaging. Parts cannot have been installed, painted and/or modified in any way. You must contact us to obtain a RGA # (Return Goods Authorization) before shipping your product back. All returns are subject to a 15% restocking fee. Your return must have the return authorization number clearly marked on the outside of the package and must be shipped prepaid. Packages shipped COD will be refused. Return's are subject to inspection and maybe refused if they are damaged or used. You are responsible for proper shipping to ensure product is not damaged or lost. We recommend insuring your product for the full amount in the case it is damaged or lost during return shipment.

Warrantee Policy: Clayton Off Road Mfg. comes with our abuse proof limited lifetime warrantee against bending or breaking our control arms only. This covers the original purchaser of our suspension lift. This warrantee cannot be transferred to a secondary purchaser and is void if the control arm is modified in any form or not used in its proper application. Original purchaser must obtain a RGA # and is responsible for shipping the product back and agrees to return shipment charges. This warrantee does not cover worn bushings, missing snap rings, or any kind of rust damage to the threads or inserts or actual arm.

What is not covered:

Clayton Off Road Mfg. components may have minor finish damage to powder coated or plated surfaces, which may occur during shipping and is not covered under warranty. Johnny Joint bushings, washers, snap rings, OEM rubber bushings, hardware, brake lines, shocks, springs, skid plates, trackbars, and any mounting brackets are not covered. These parts are subject to wear and are not considered defective when worn. They are warranted for 90 days from the date of purchase for defects in workmanship only. Products or components which have been subjected to abuse, accident, alteration, modification, improper installation, tampering, negligence, misuse, or products installed on a vehicle used in sanctioned racing events. A race is defined as any contest between two or more vehicles, or any contest of one or more vehicles against the clock, whether or not such contest is for a prize.

Clayton Off Road Mfg. is not responsible for any retail parts that maybe sold.

Clayton Off Road Mfg. shall not be liable for any loss, damage or injury, whether ordinary, direct, special, incidental or consequential damages, arising from the manufacture, sale, installation, resale, delivery, possession, handling or use of its products.

Clayton Off Road Mfg. is not responsible for typographical errors either in pricing or in content.

Warranties, policies and prices subject to change without notice.